

makerzoid

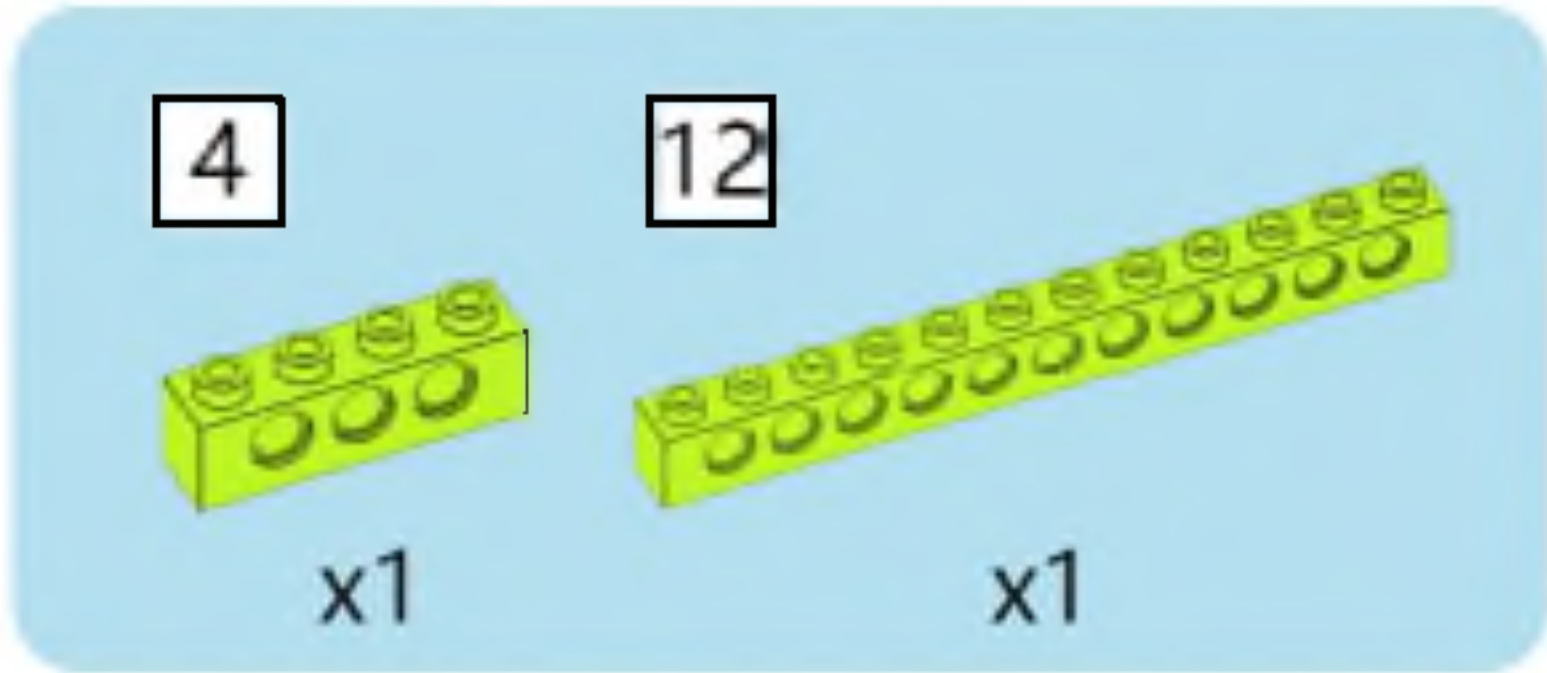

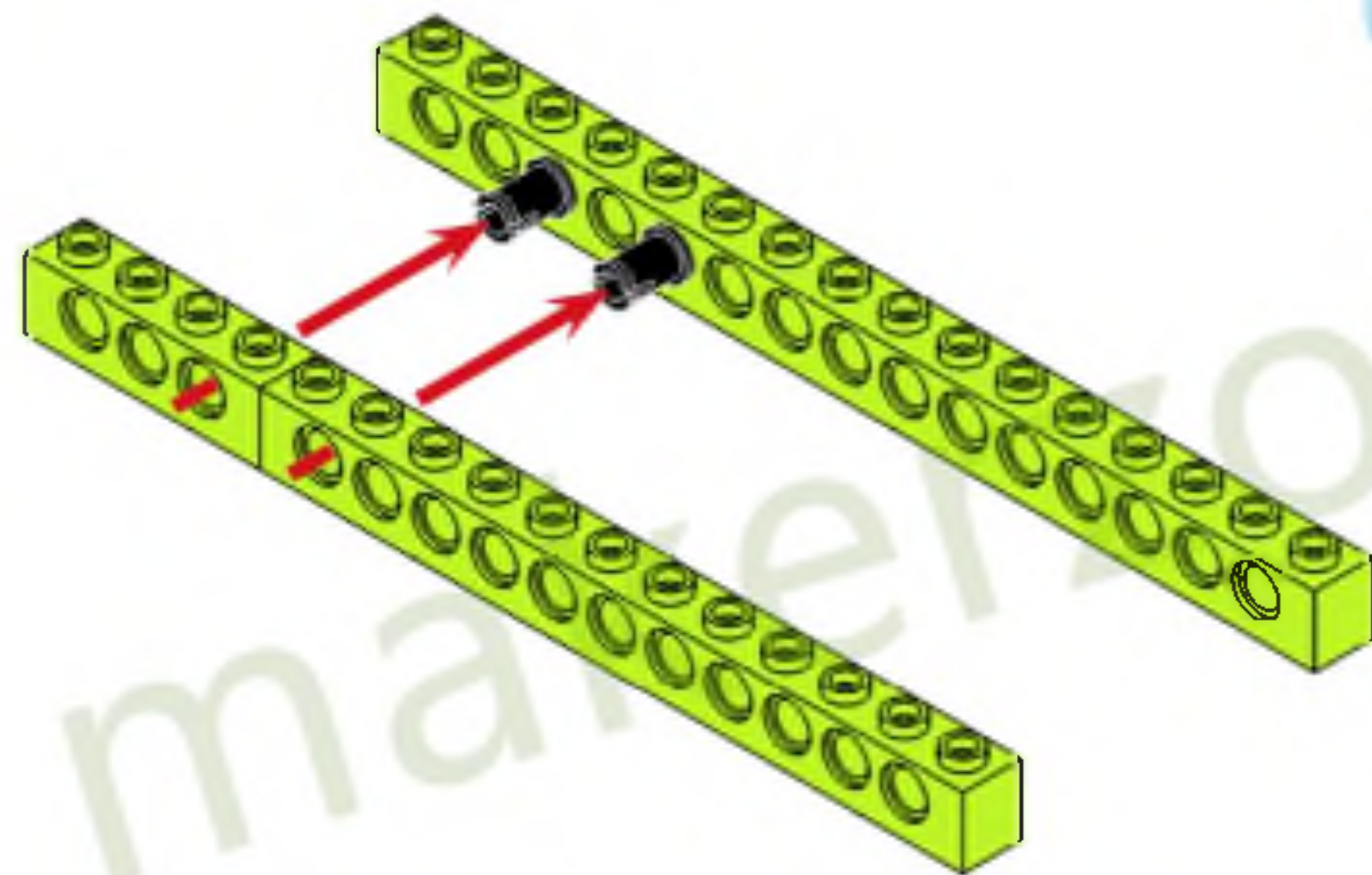

makerzoid

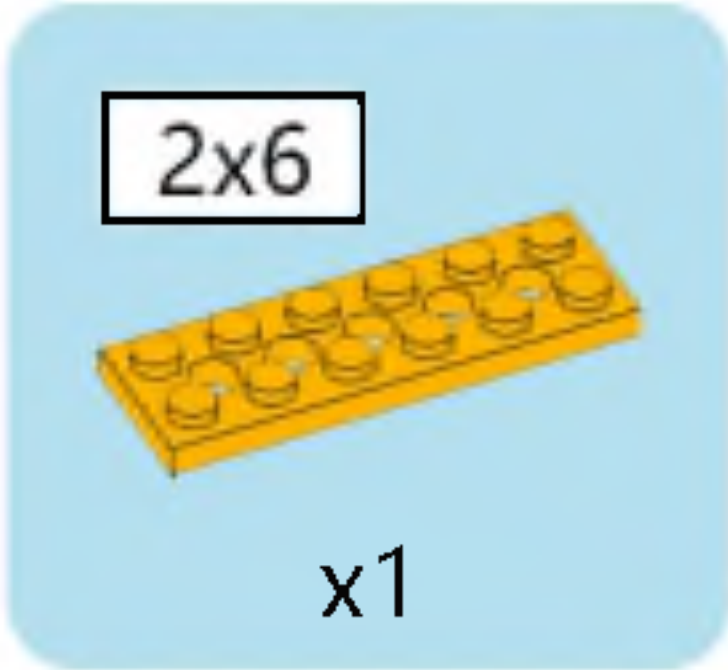
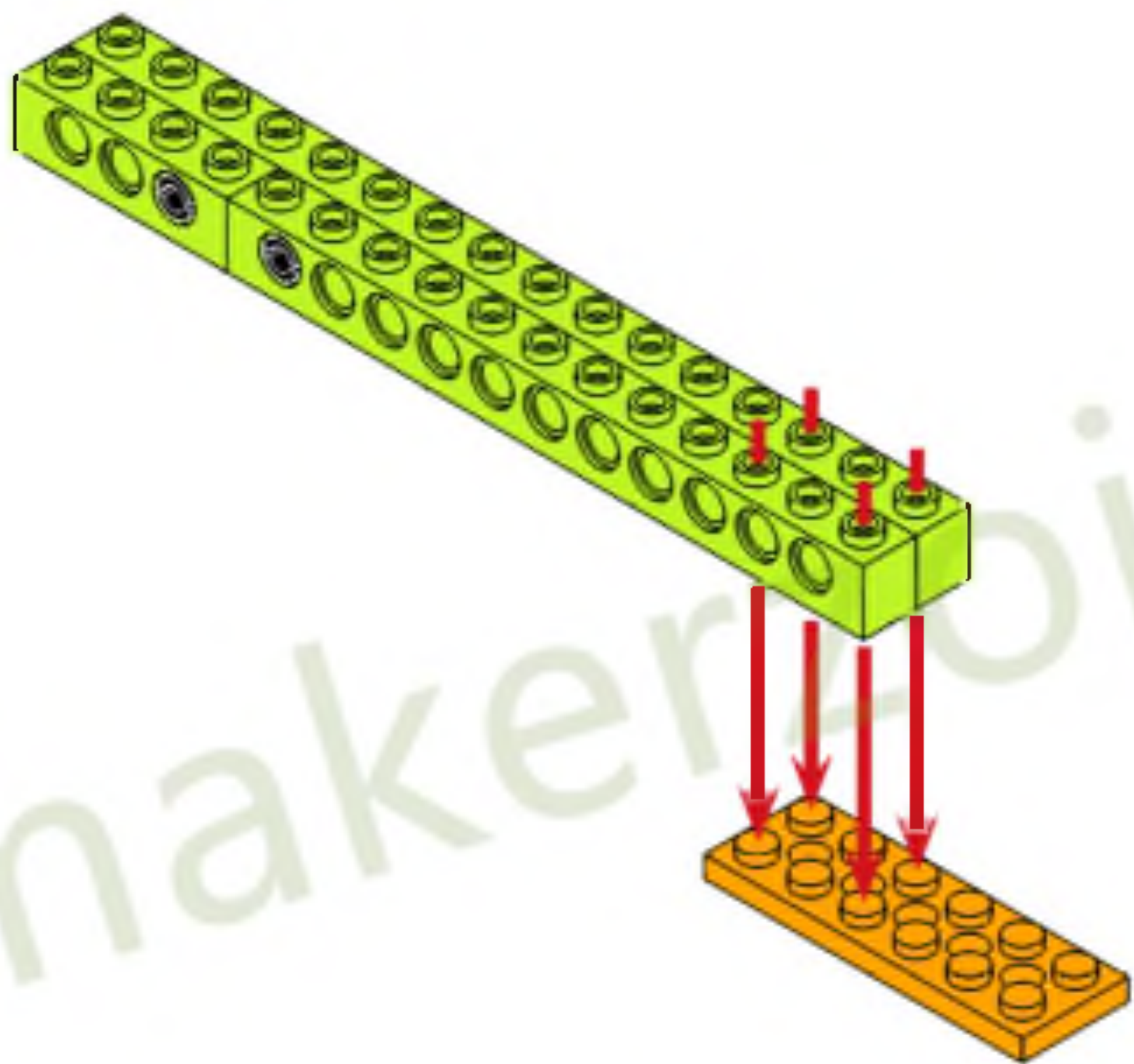
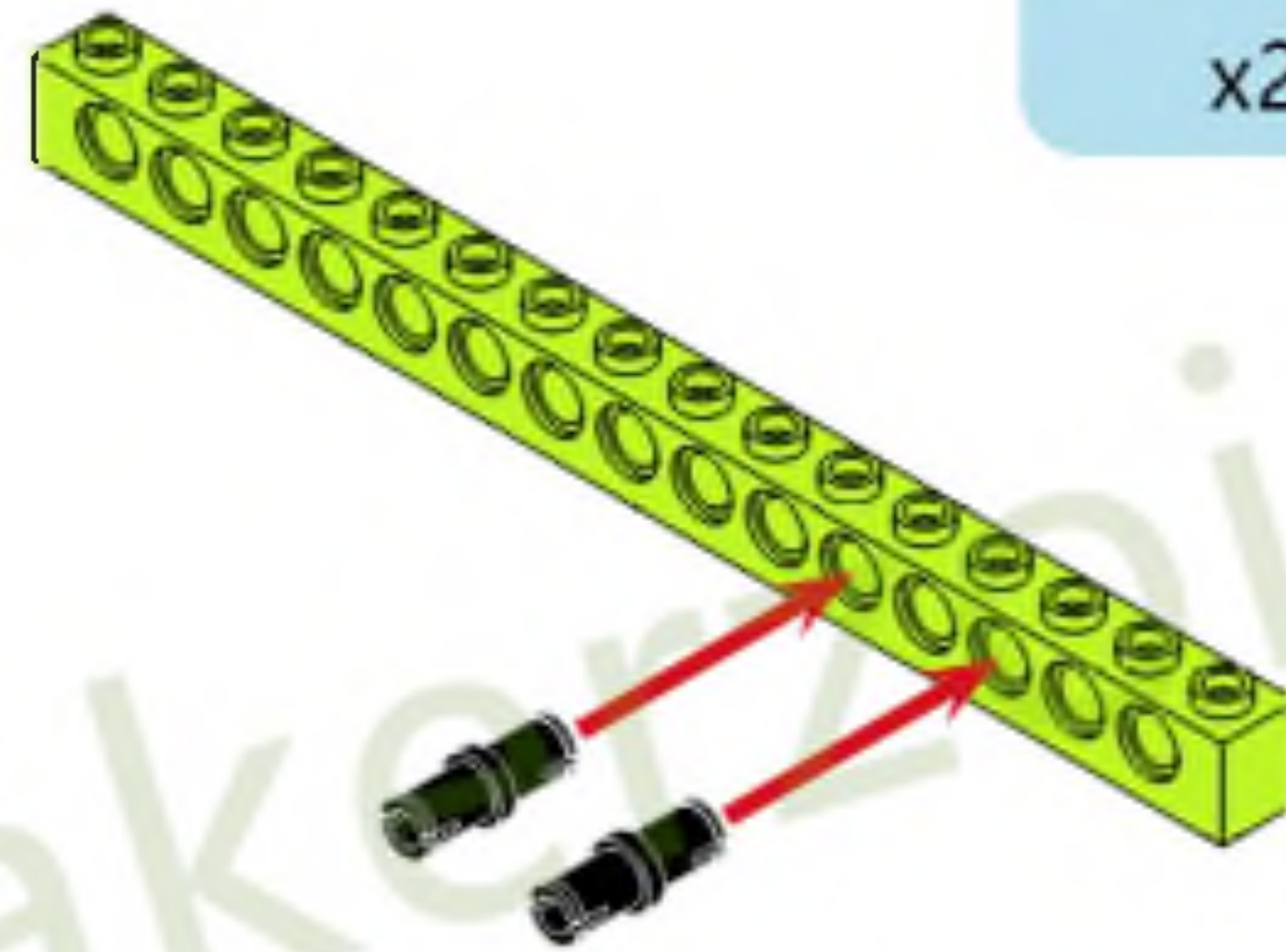
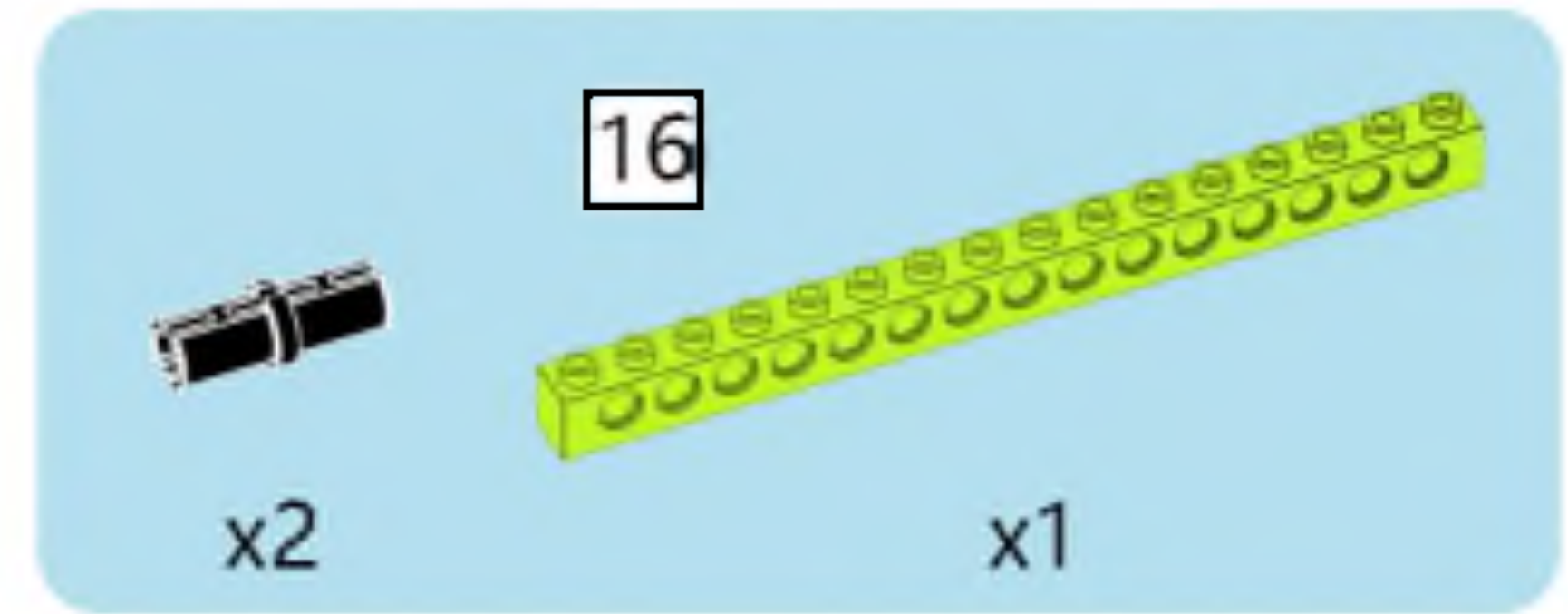

makerzoid

4



x1

12



x1

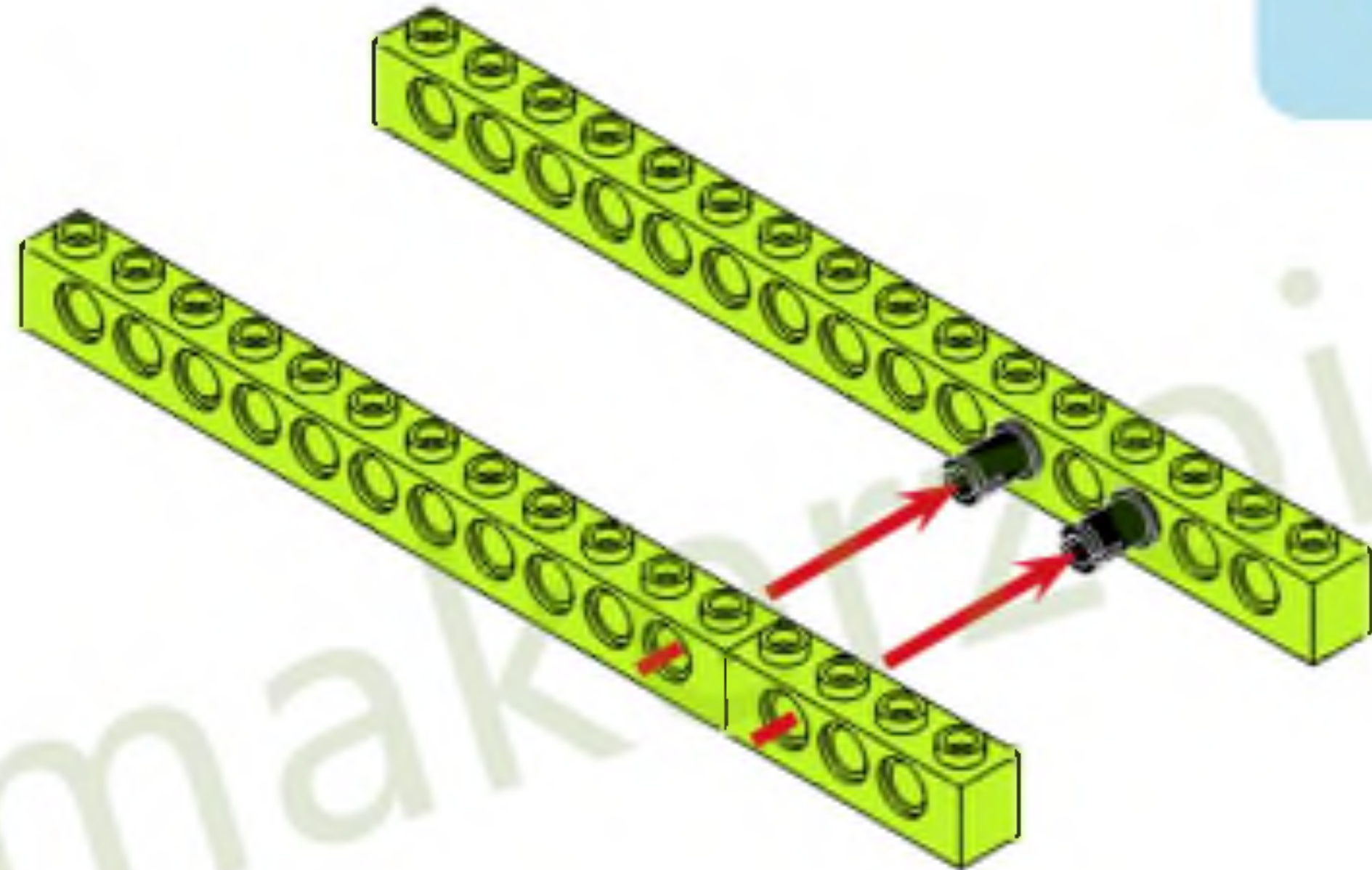

makroid

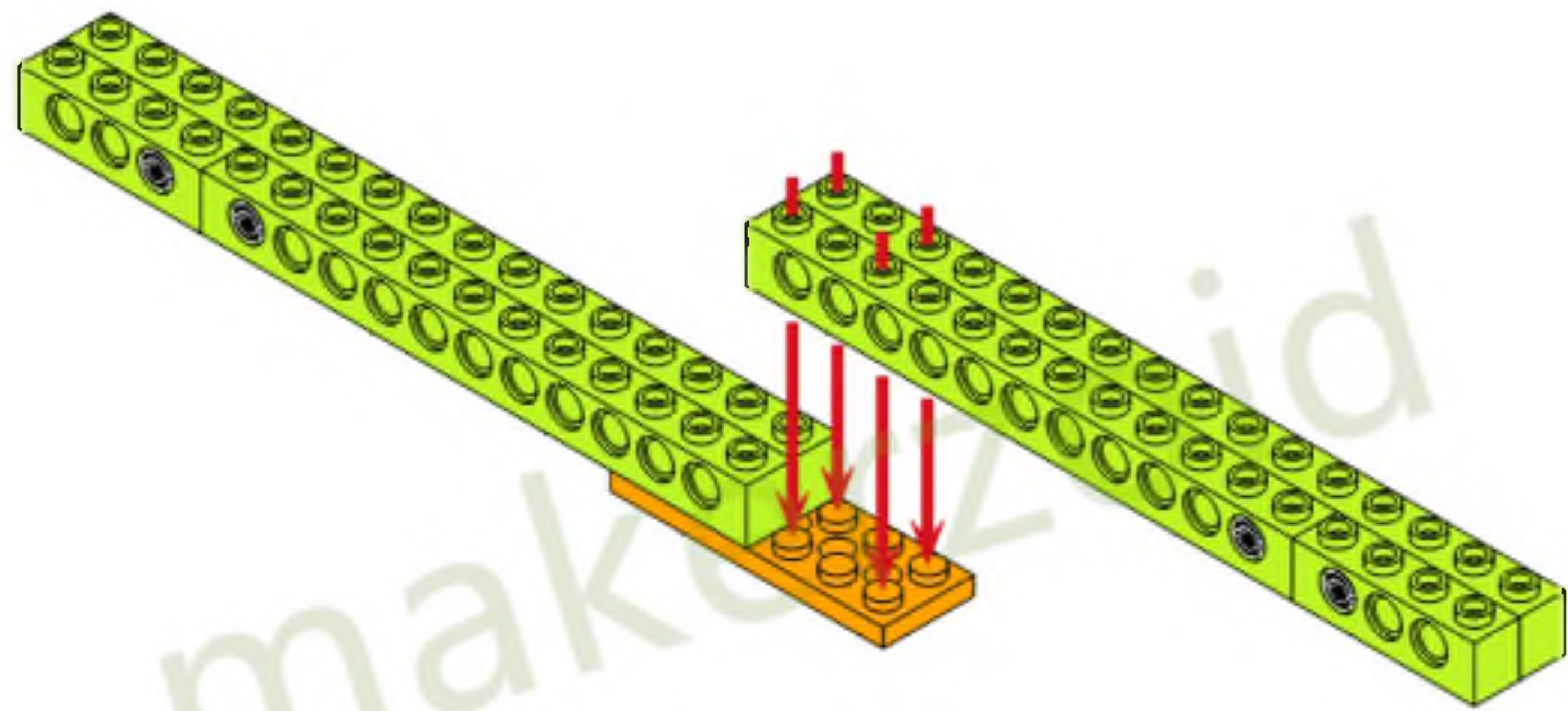

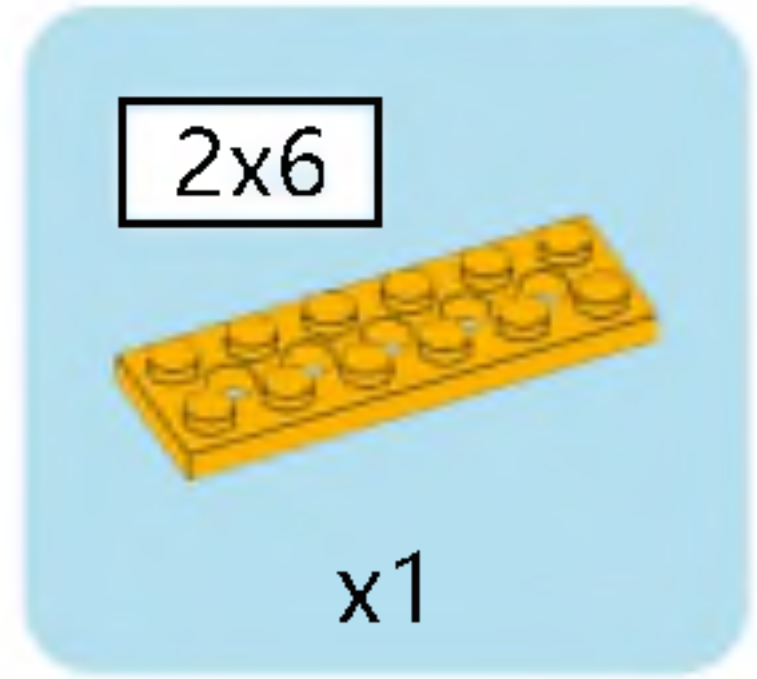
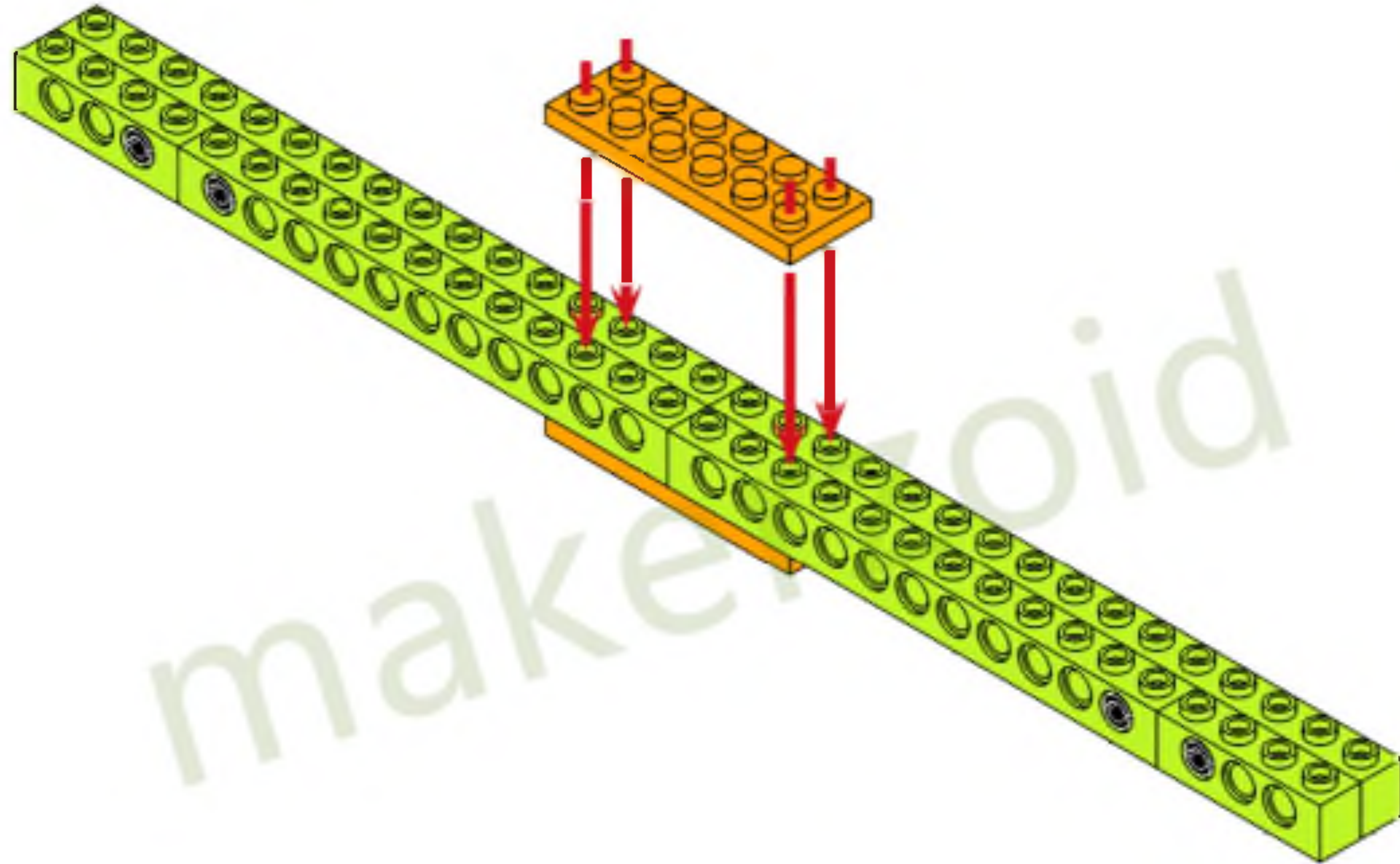

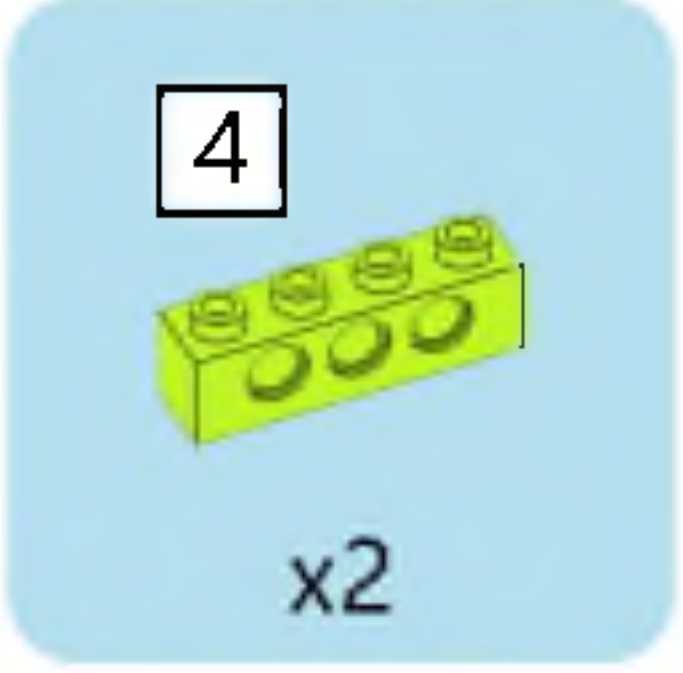
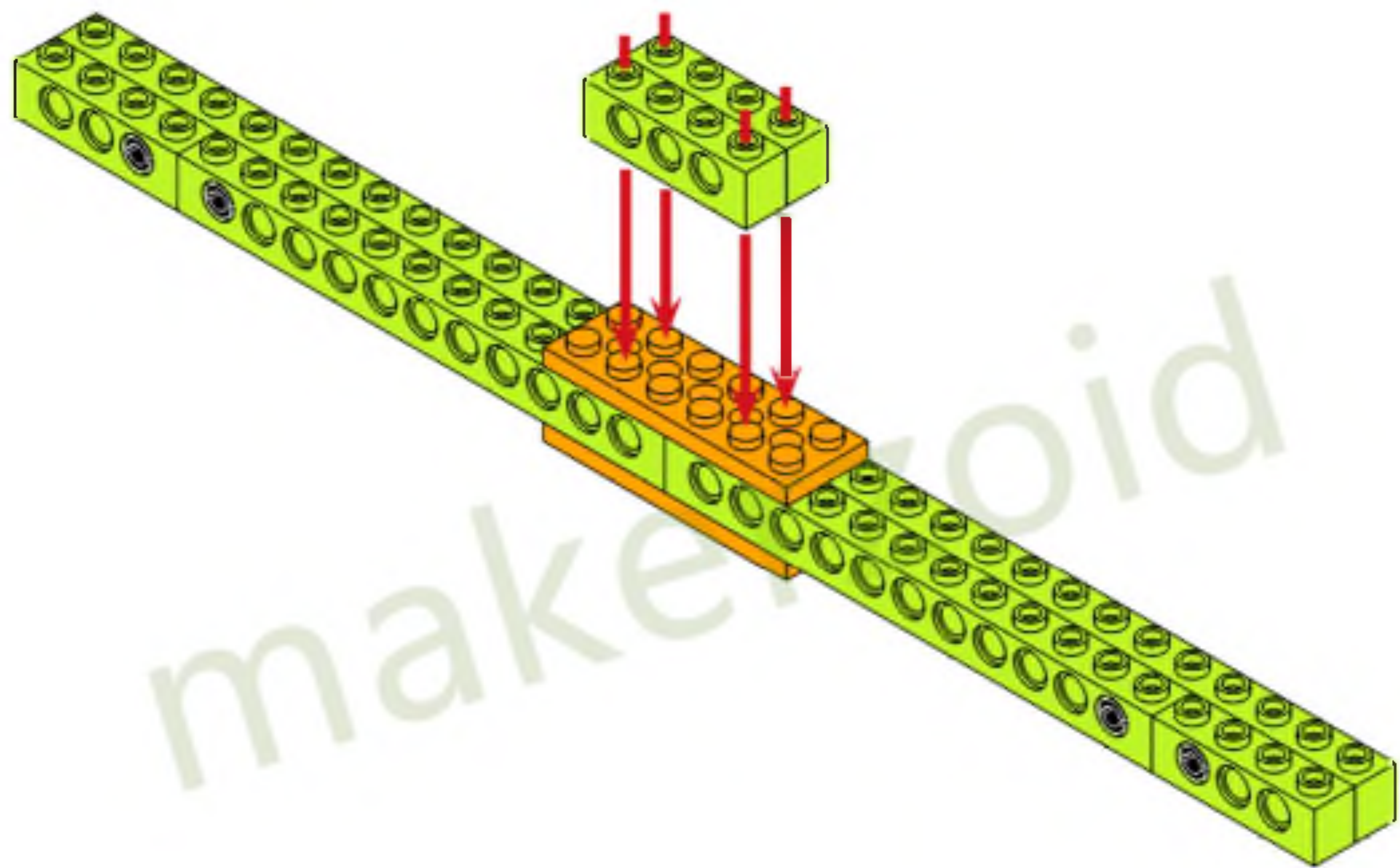

make:roid



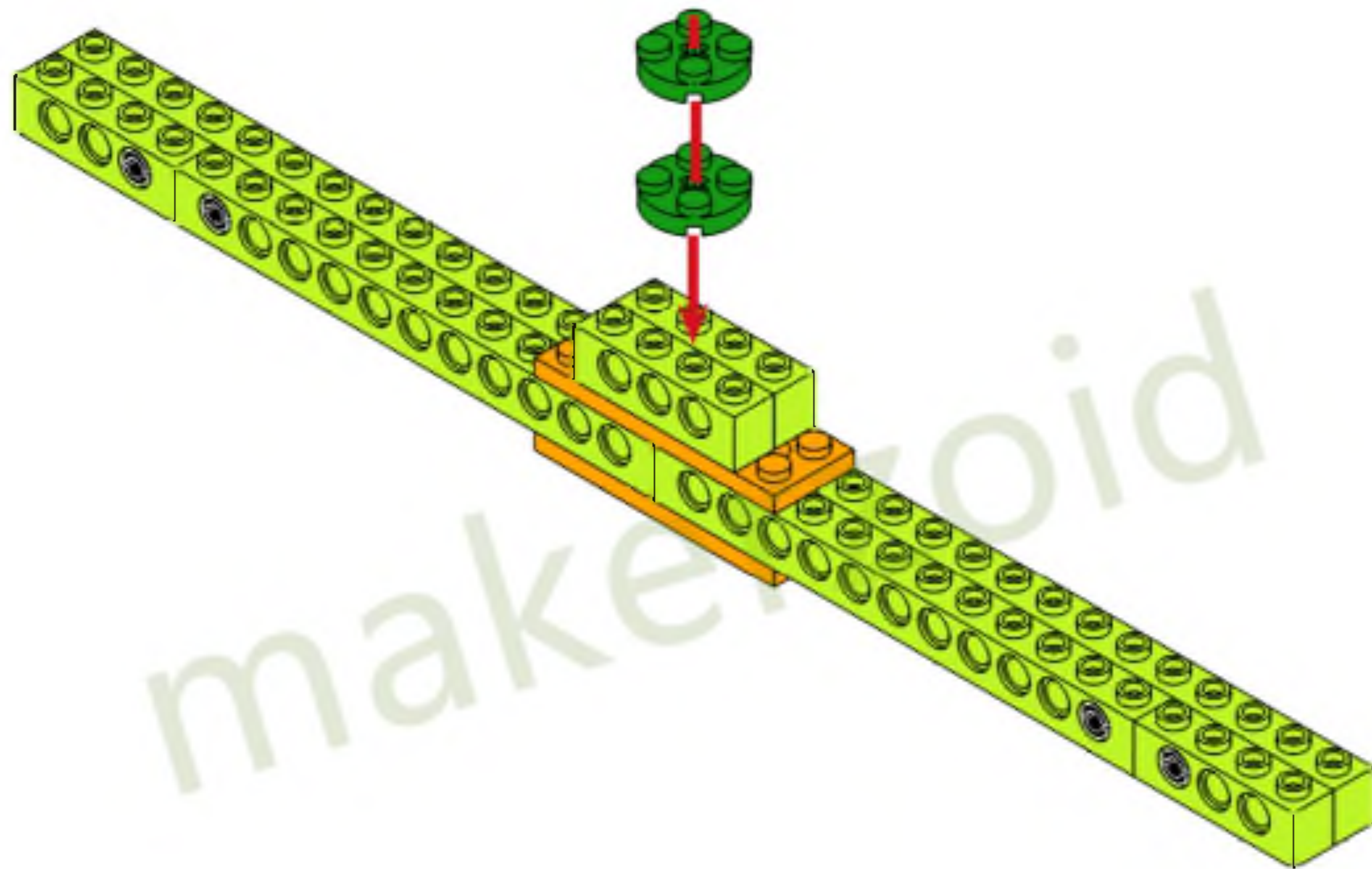

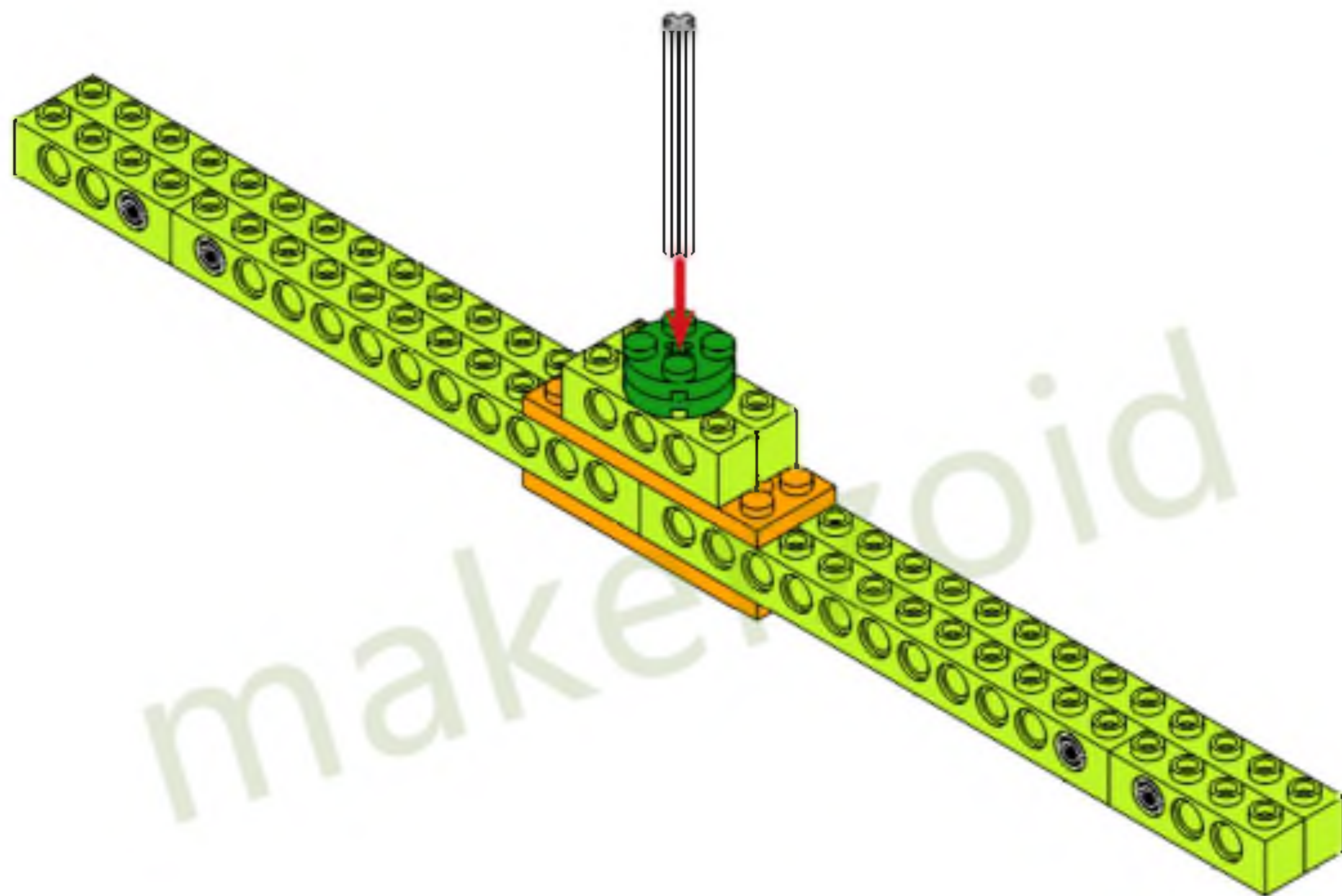

5



x1

makeroid

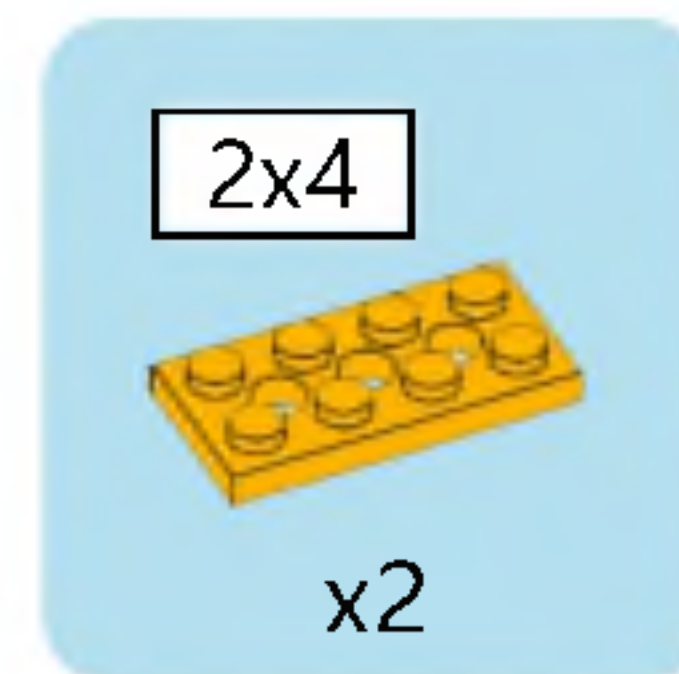
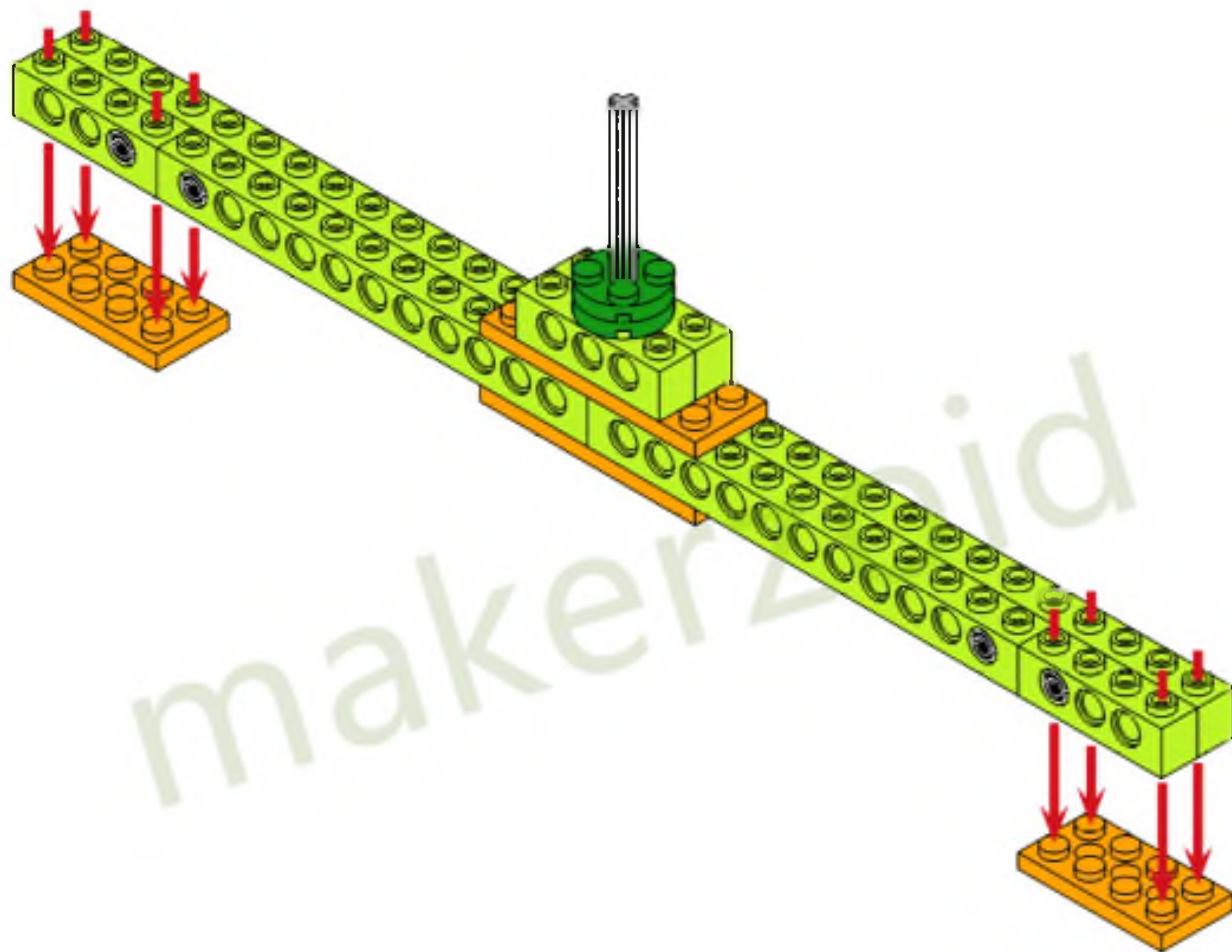

makerzoid

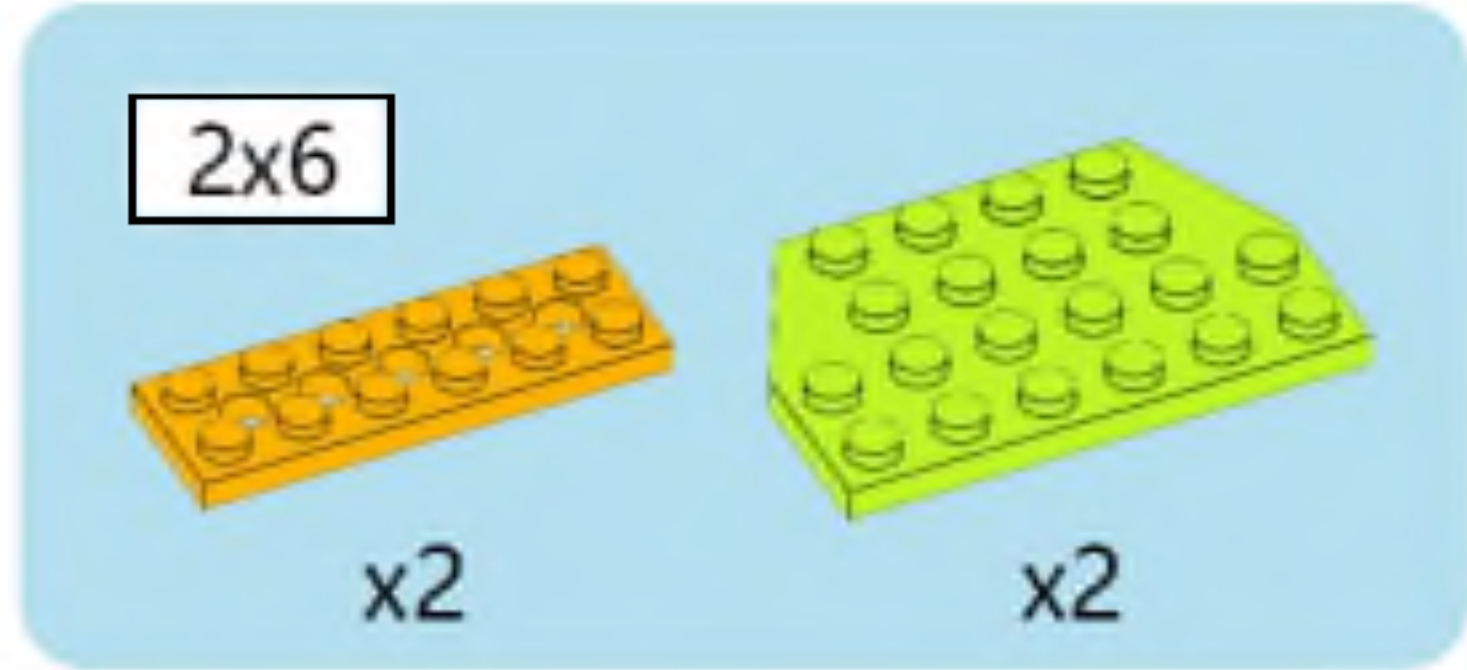
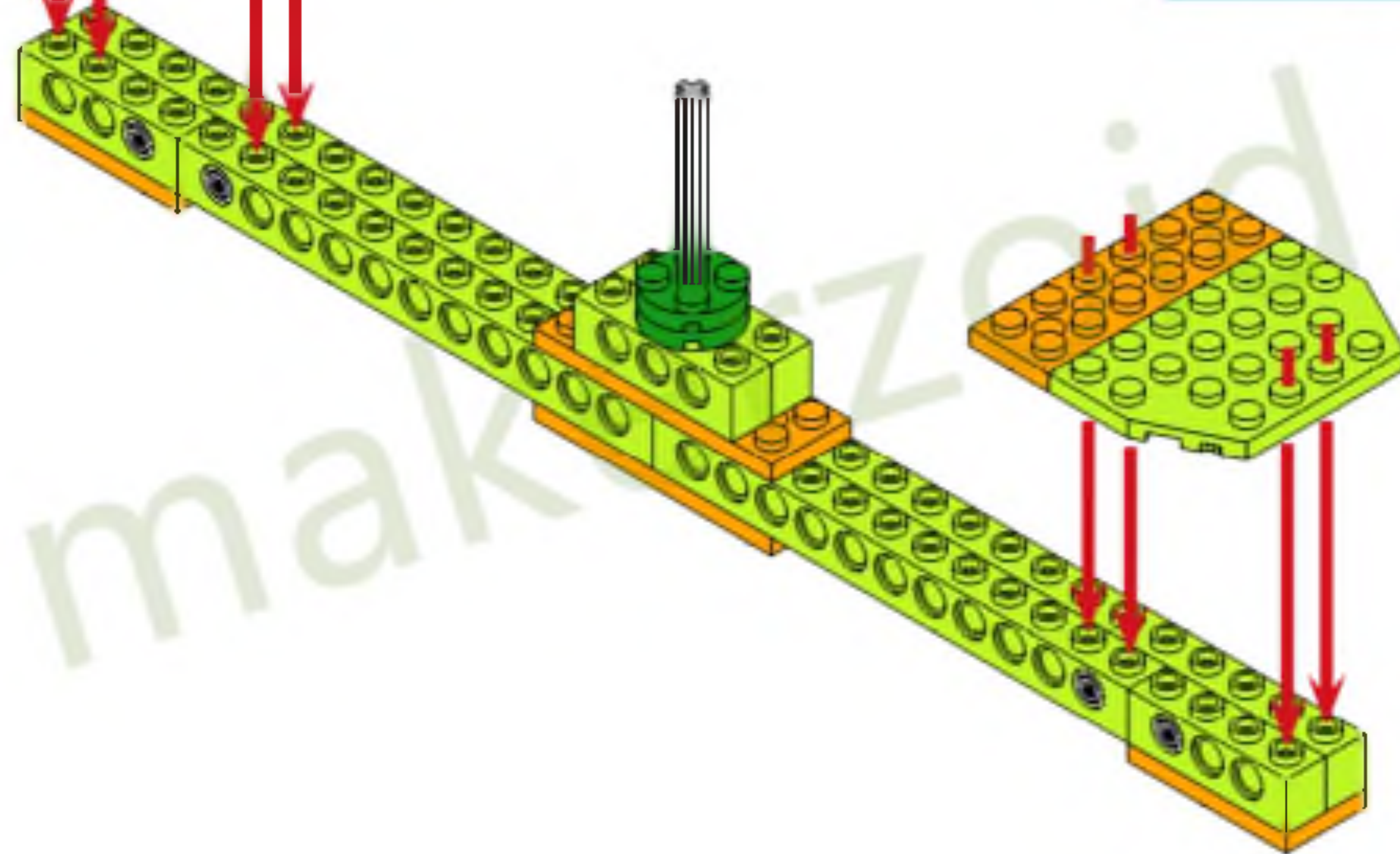
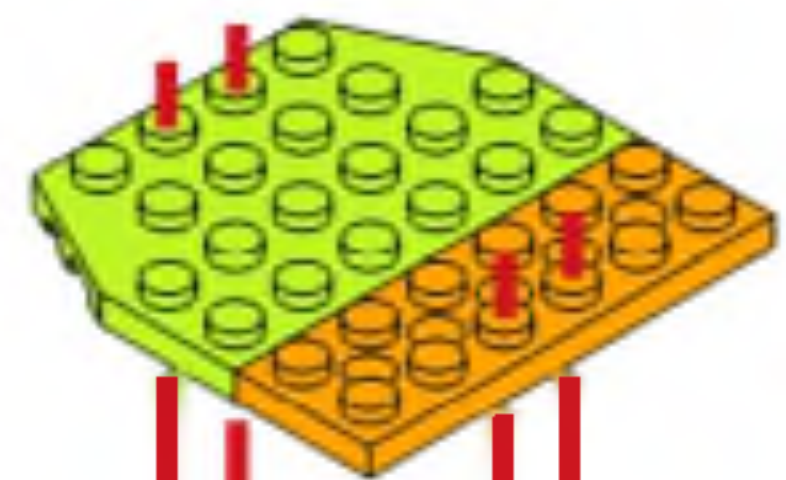

makzoid

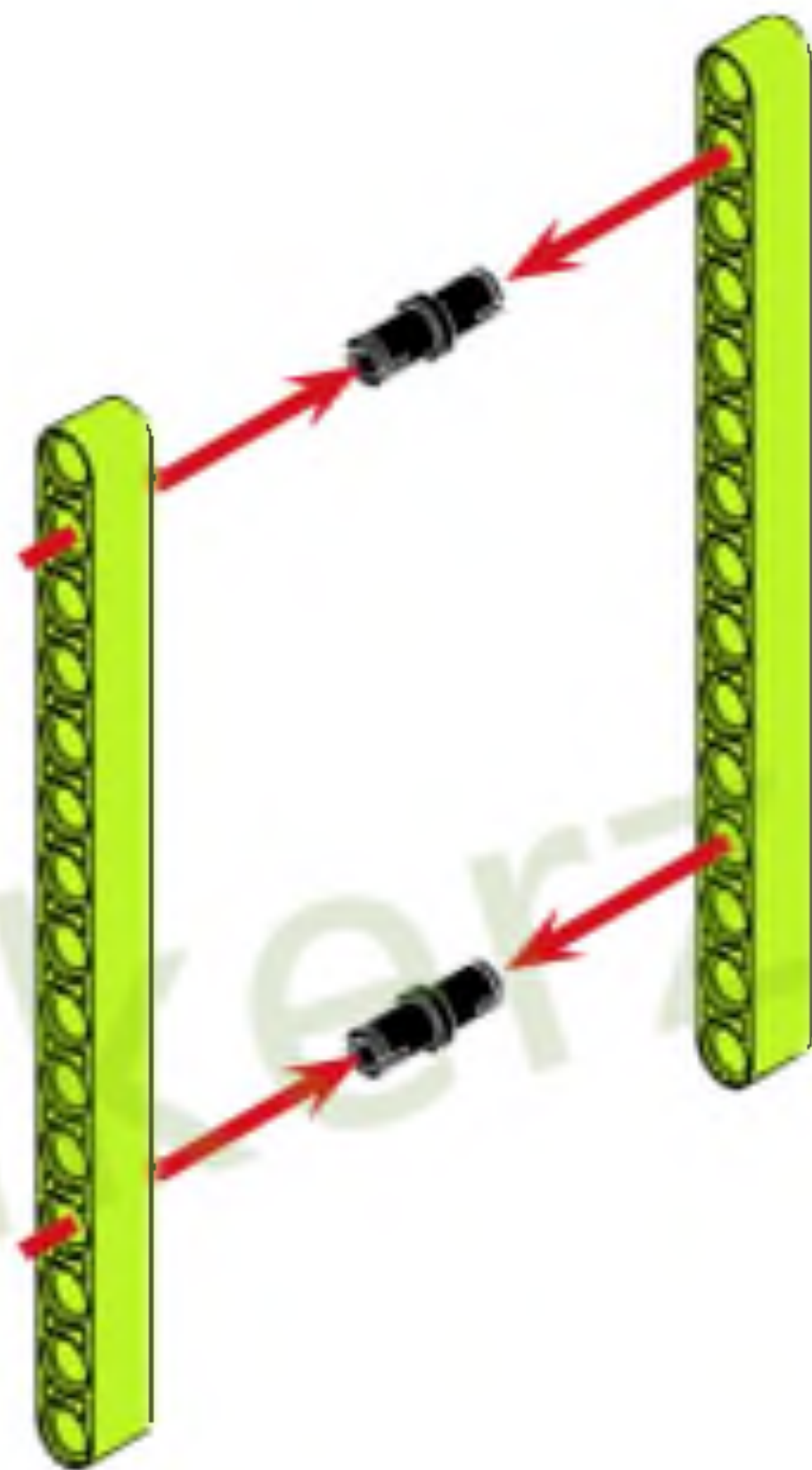

A light blue rounded rectangular box containing a parts list. On the left is a black pin with the label 'x2' below it. On the right is a yellow Technic beam with the label 'x2' below it. A small white box with the number '15' is located above the yellow beam.

makerzoid

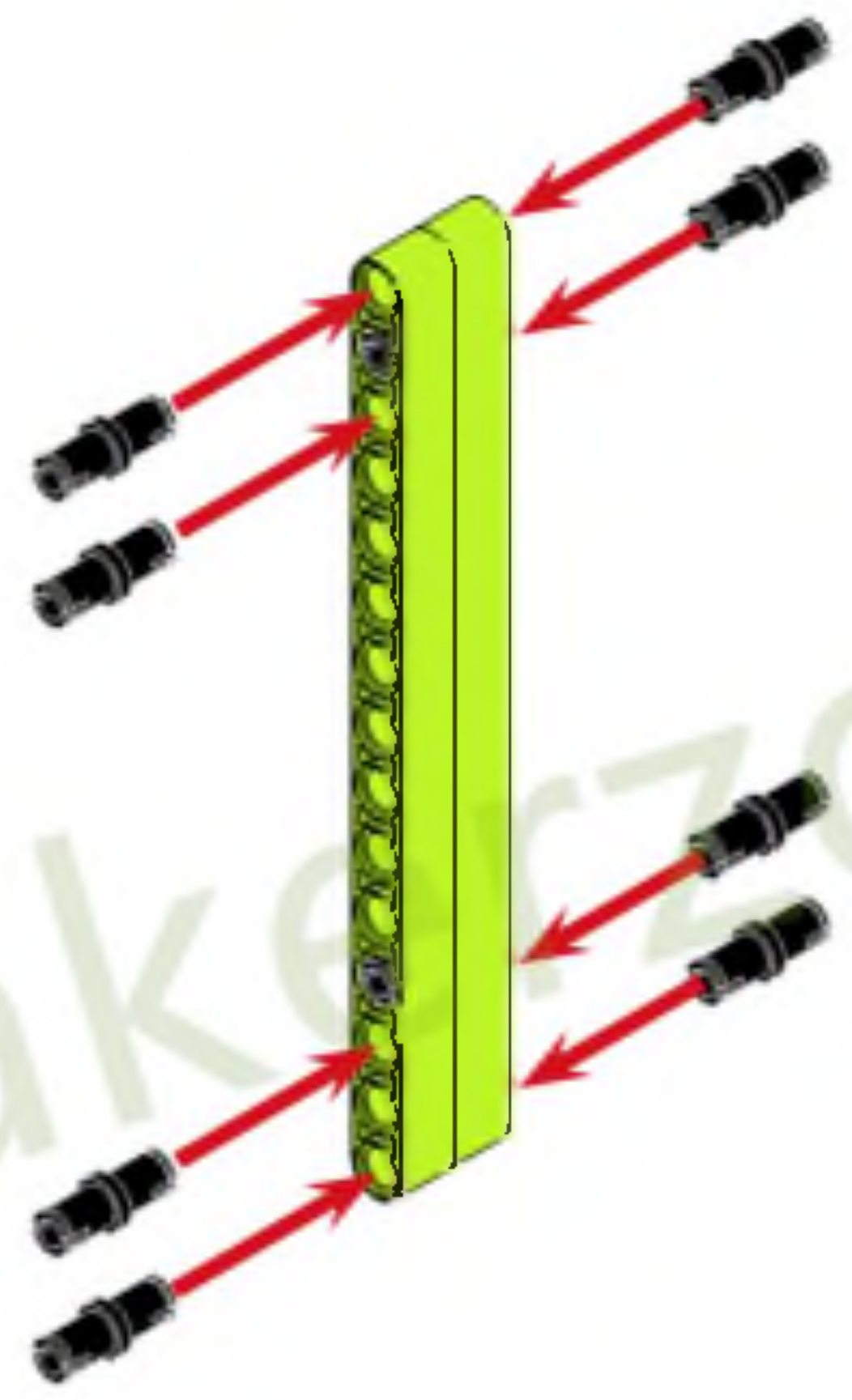

makeczoid

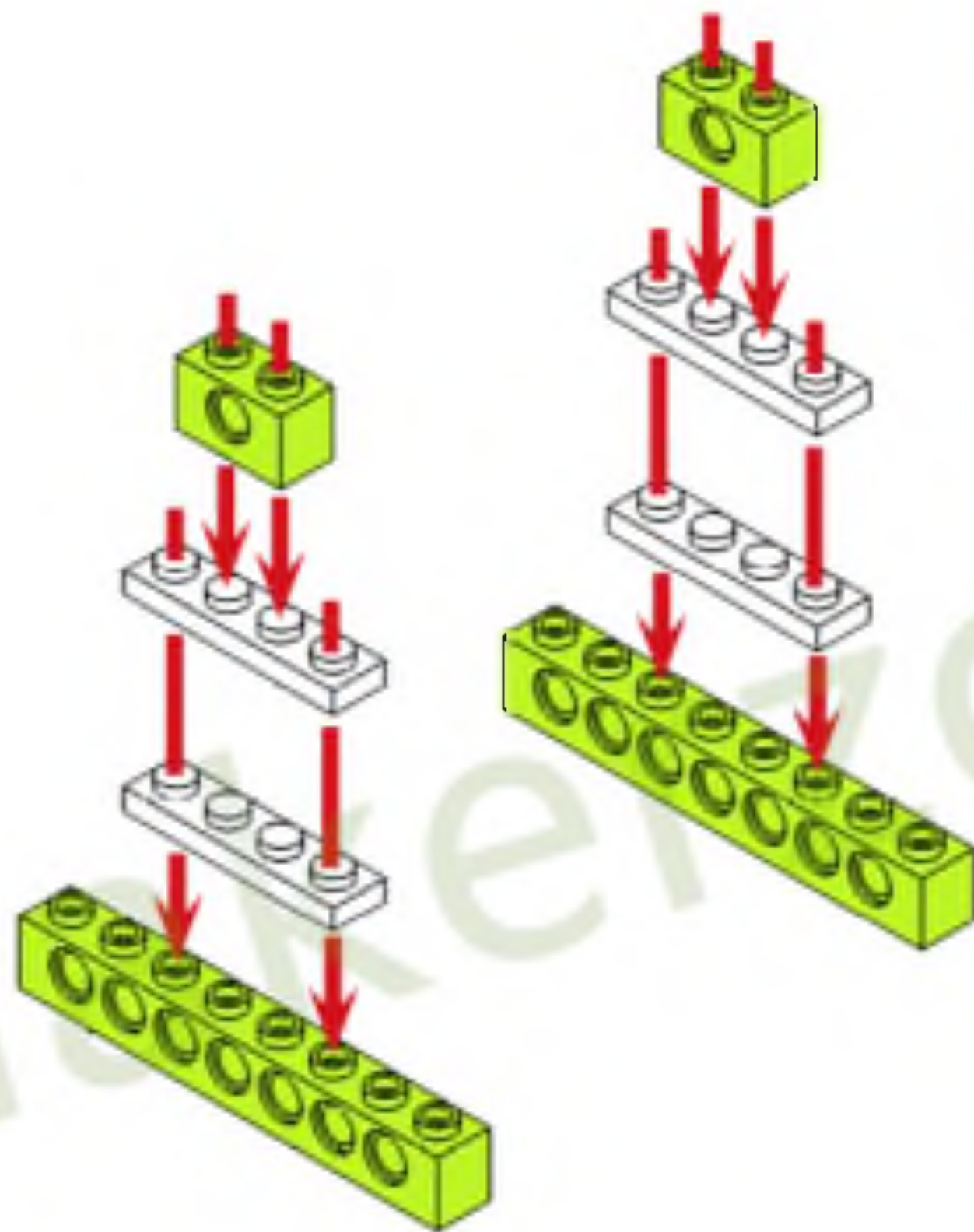

x2      1x4      8      x2

maxeroid

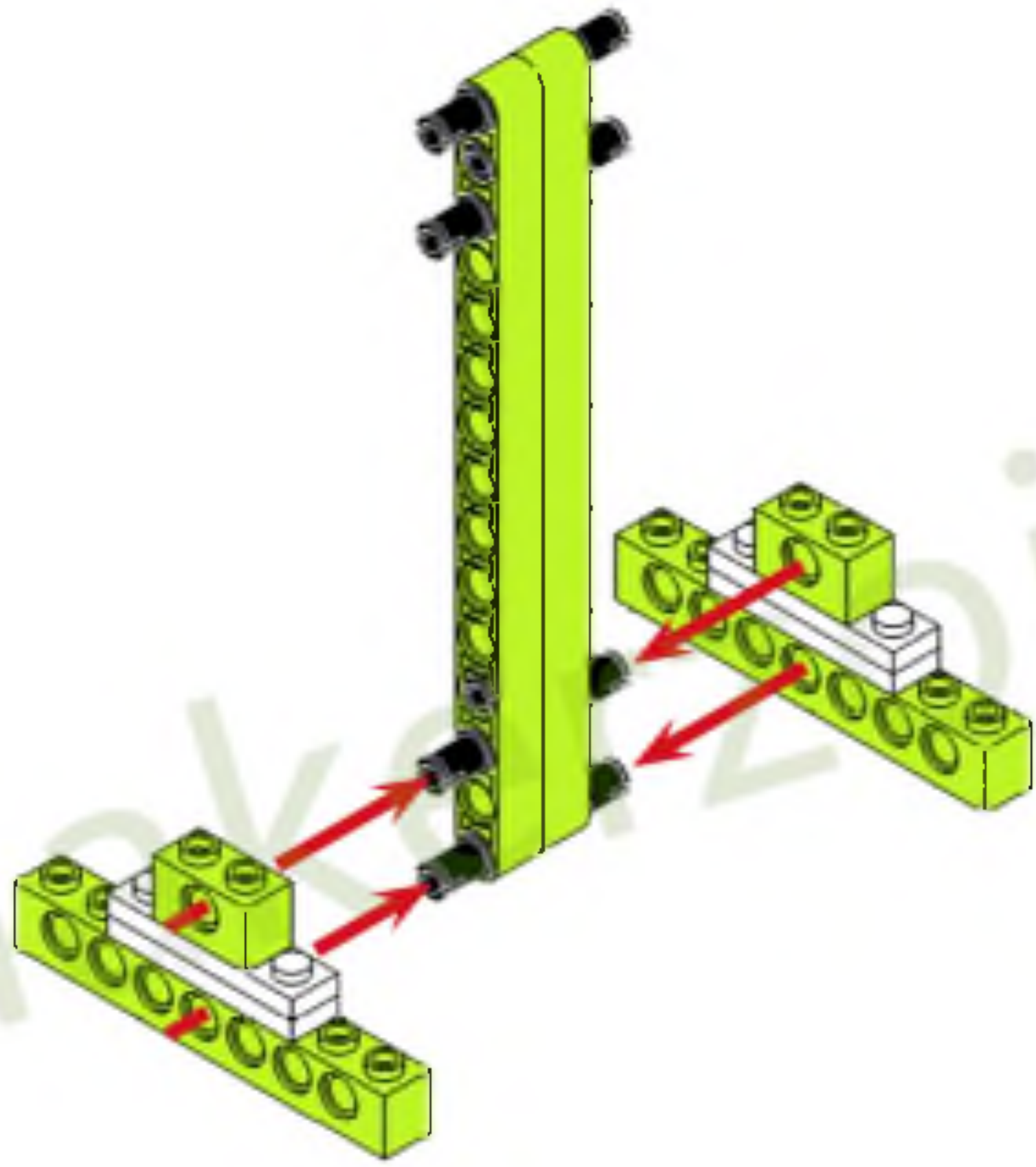



makezoid

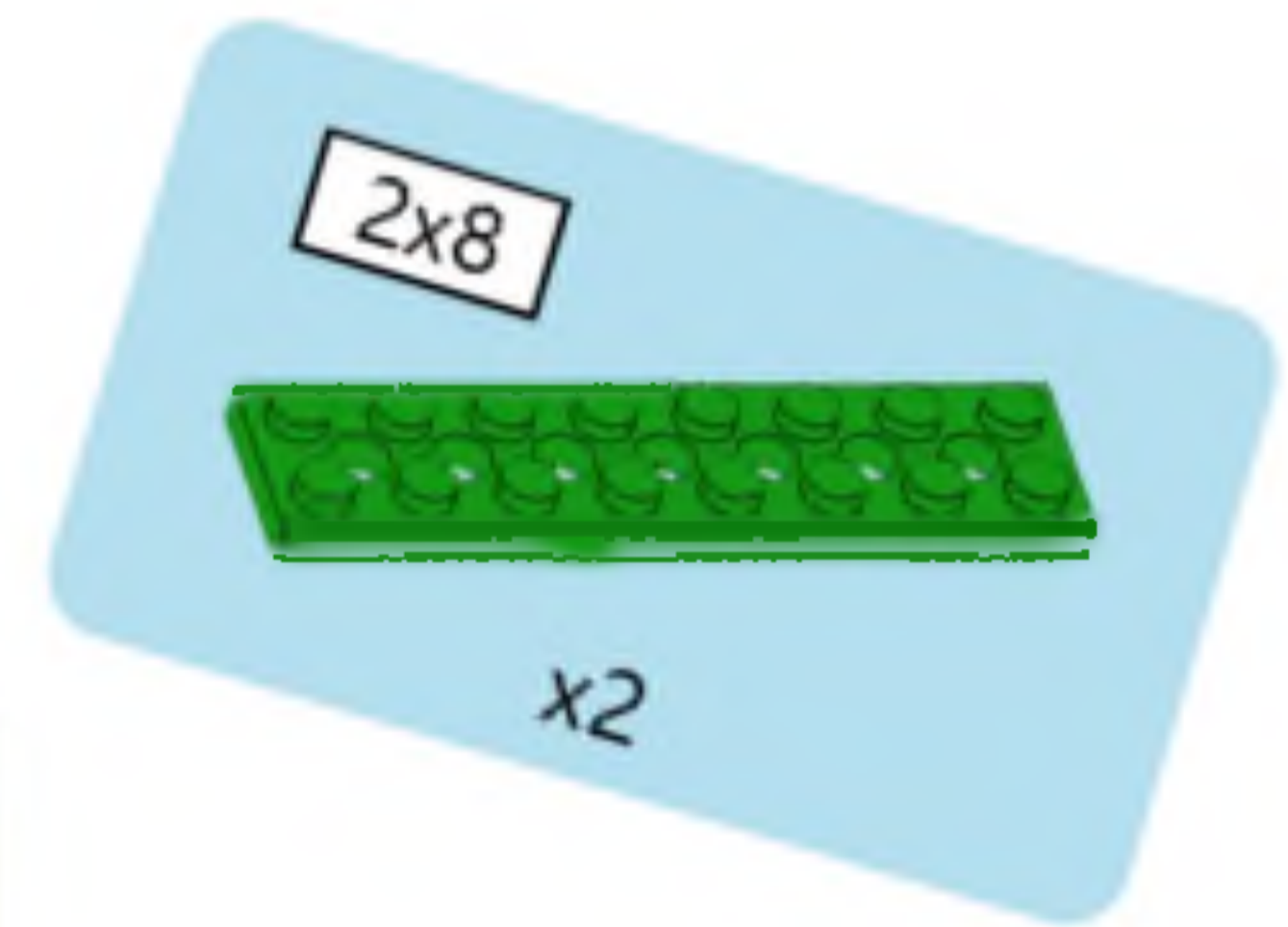
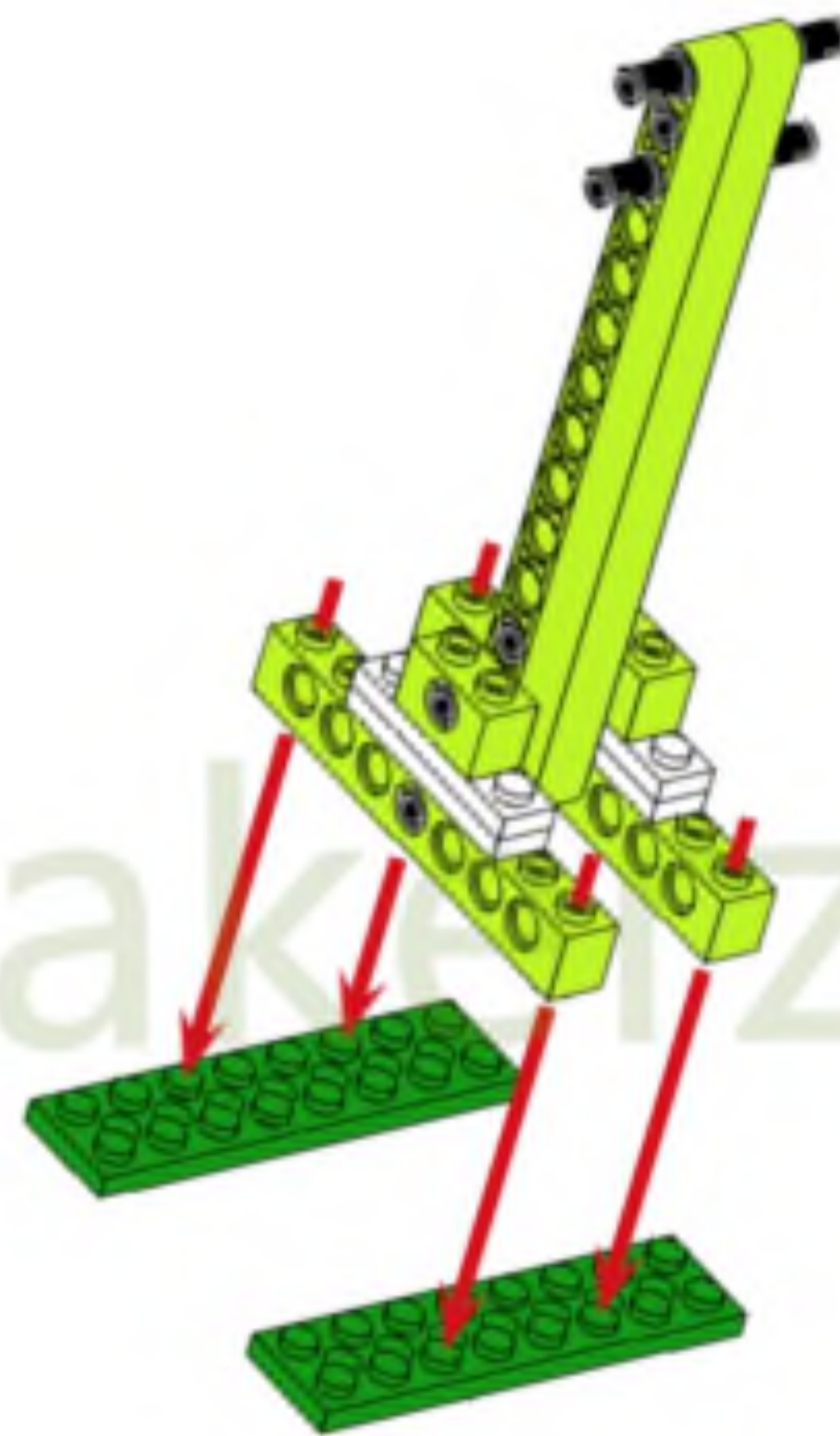

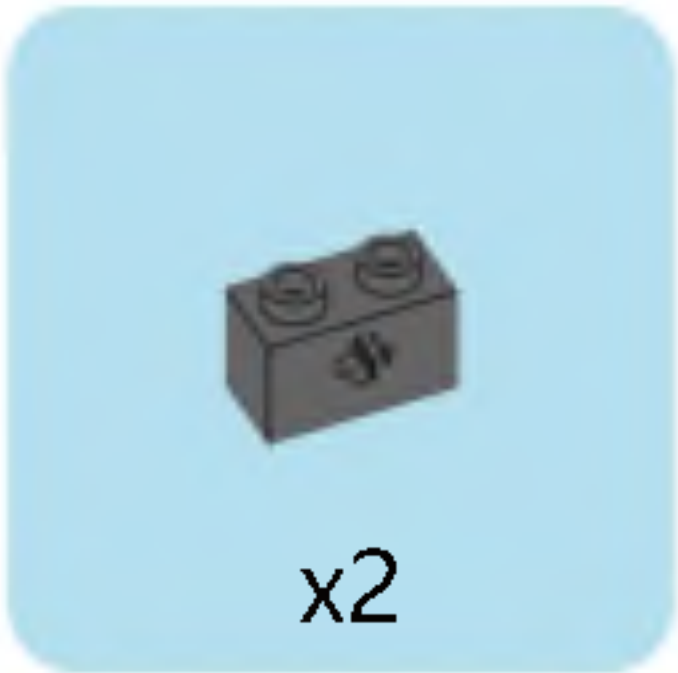
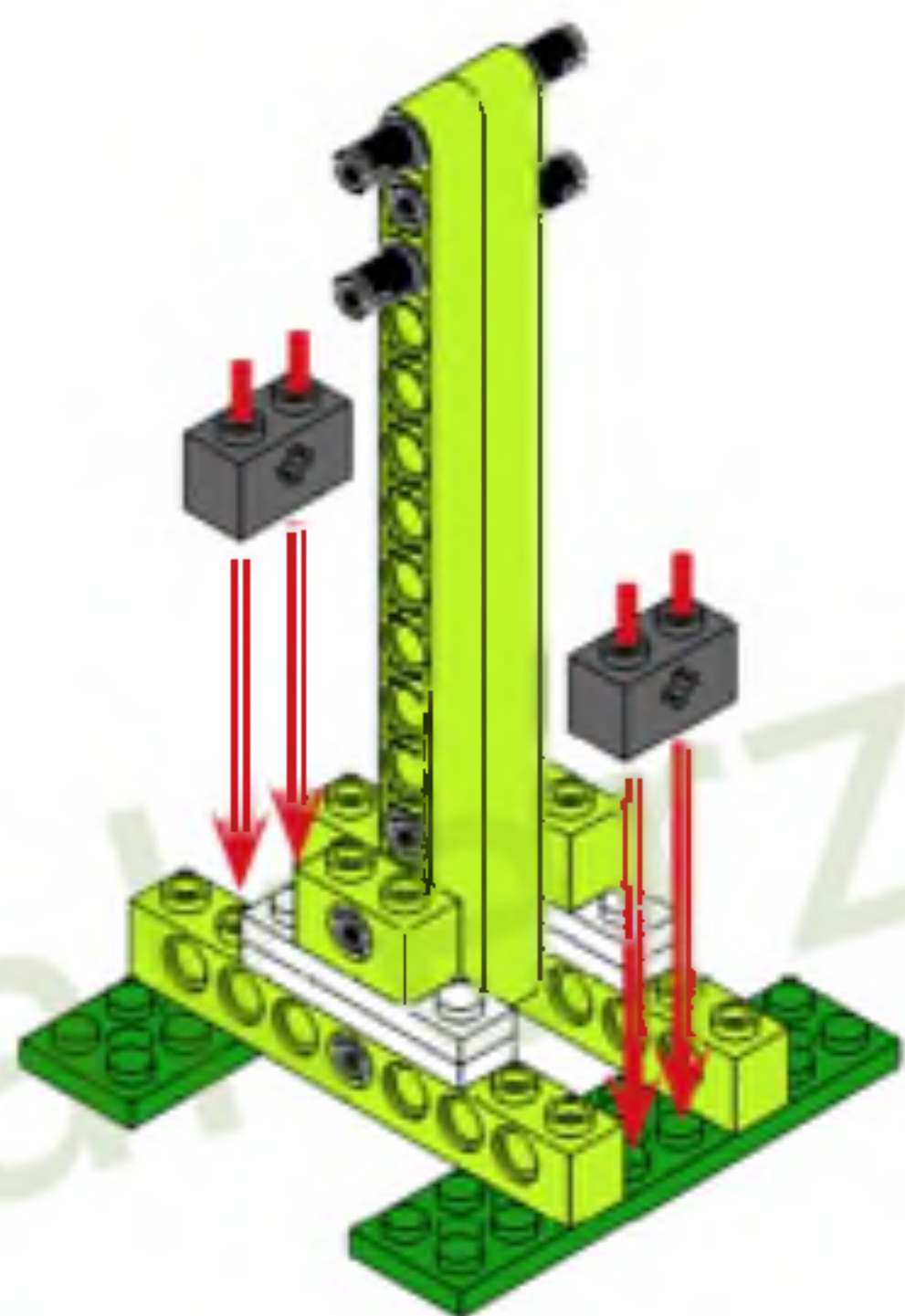

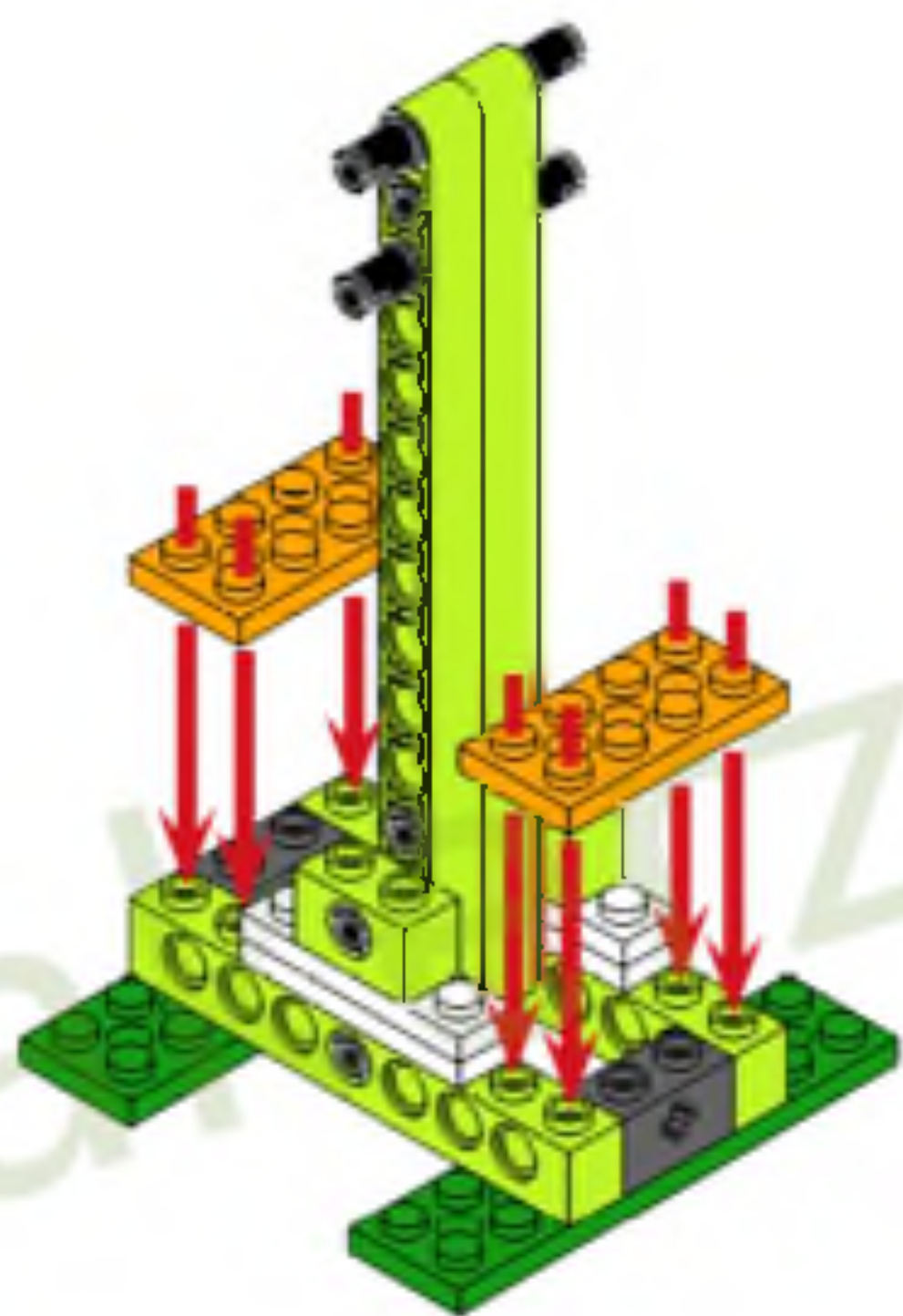

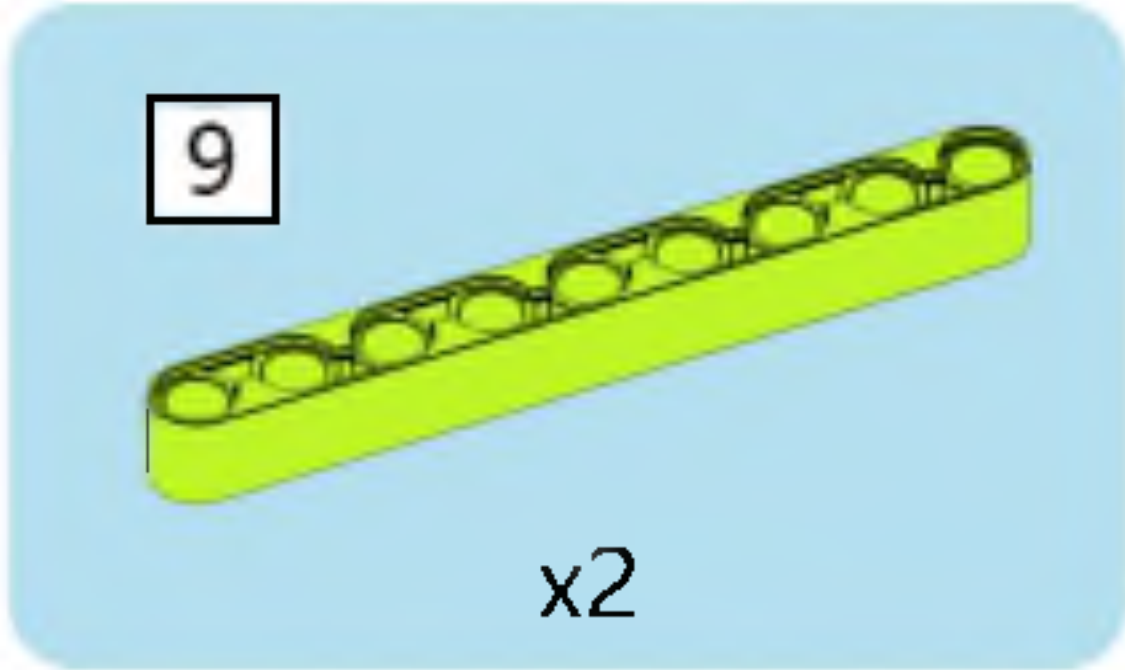
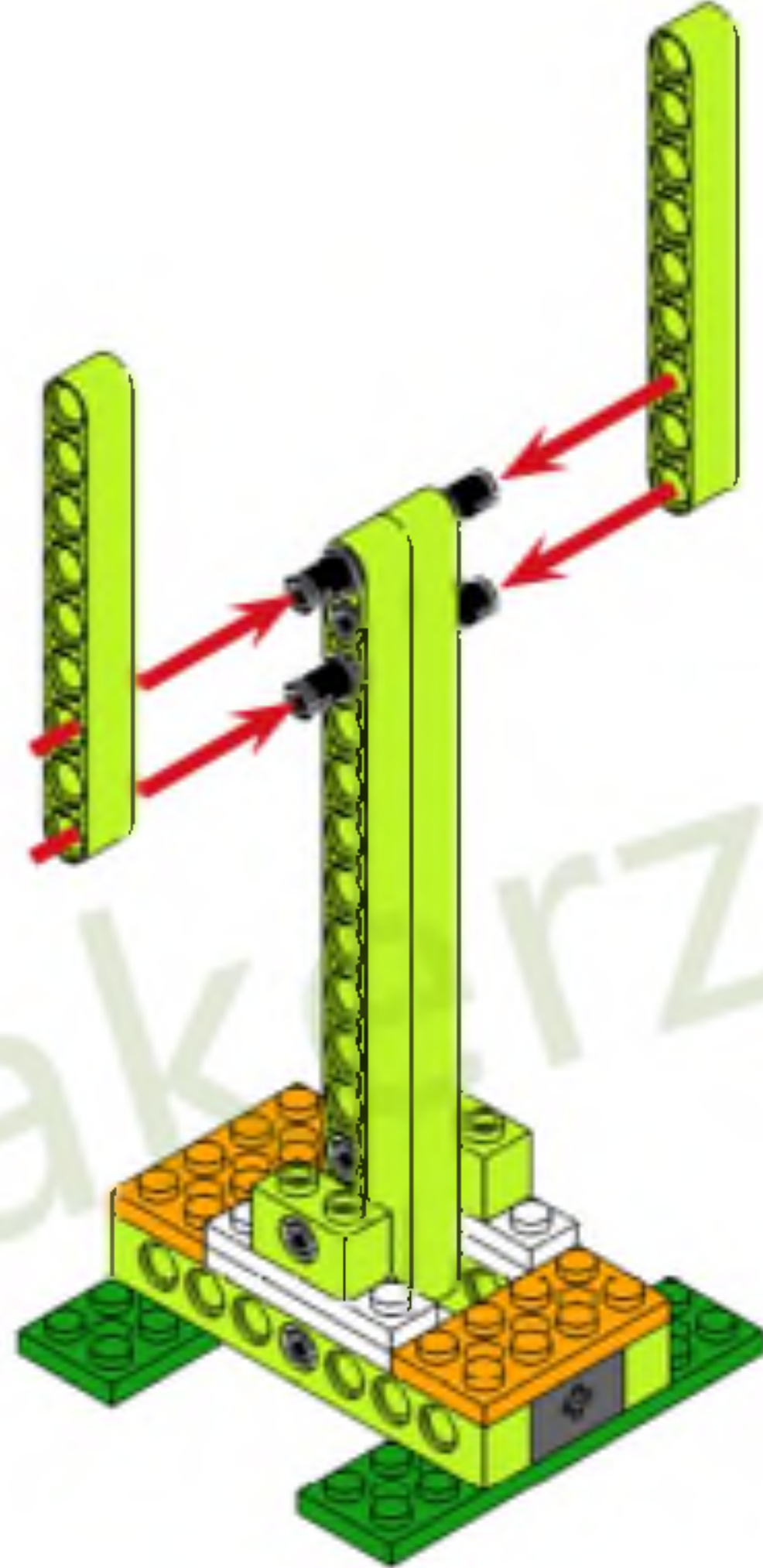



makarzoid

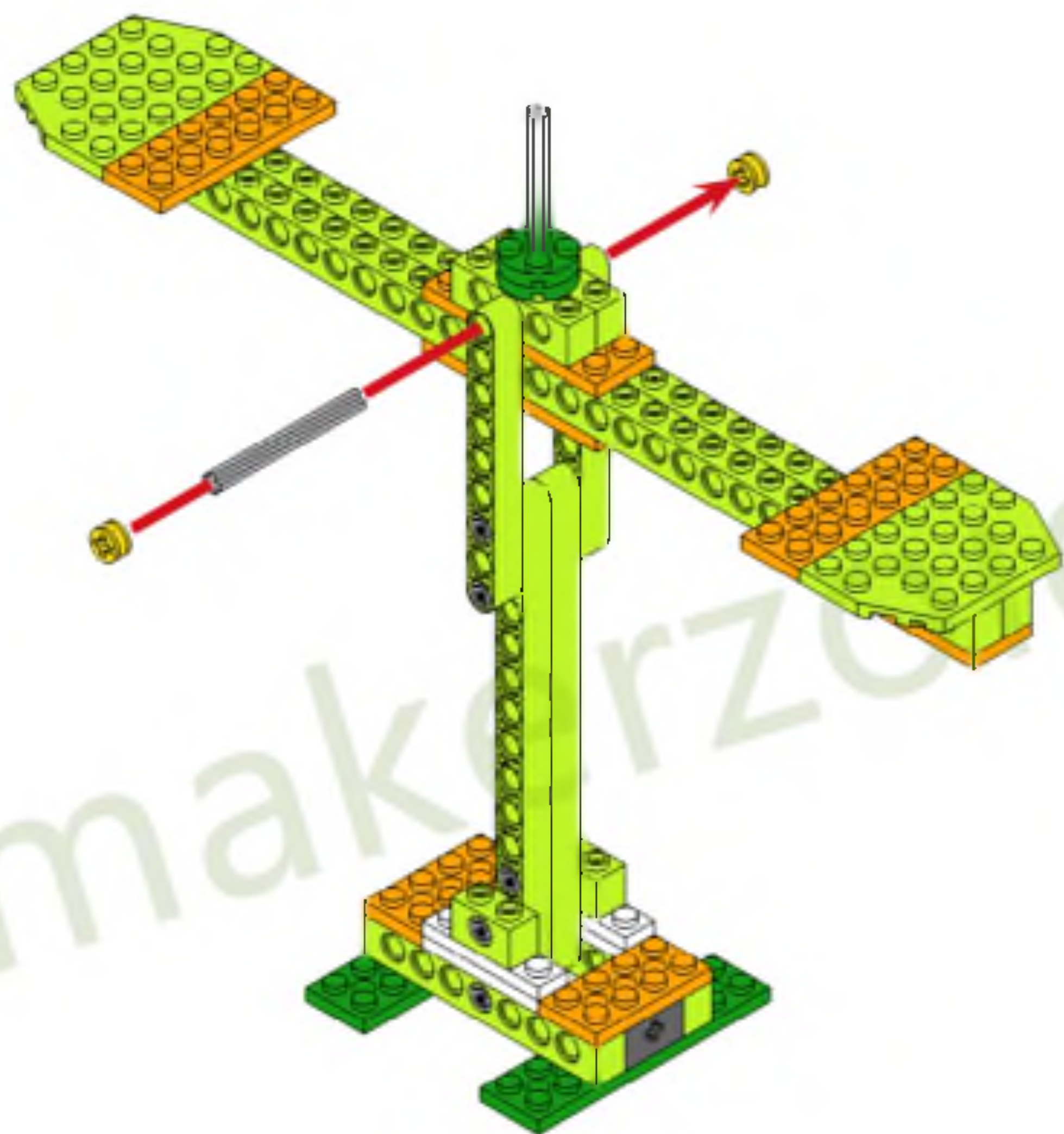

makerzoid



5

 x2

 x1

makerzoo

